



Built-In POS

+



Kiosk Installation MANUAL



Big Daddy Games LLC

733 Midway Road
Menasha, WI 54952

TEL: (920) 727-5508

www.bigdaddygames.net
sales@bigdaddygames.net

TECH-DIRECT

(920) 850-7409

Contents

MAX CONNECT ADVANCE System Setup Overview.....	1
Items Required for MAX CONNECT Built-In and GENMEGA Kiosk Setup.....	2
STEP 1 Setting up the MAX CONNECT GAME System.....	3
STEP 2 Daisy-Chaining MAX CONNECT iConnect Boards.....	6
STEP 3 Connecting the DTECH DT-9017 Convert to the Kiosk.....	8
DTECH DT-9017 Diagram	8
GENMEGA UK 2 (UNIVERSAL KIOSK) SPECIFICATIONS	9
Genmega UK 2 Devices COM Port Assignment	10
Genmega GEMINI-D Specifications.....	11
Genmega GEMINI-D Devices COM Port Assignment.....	12

GENMEGA ATM Installation

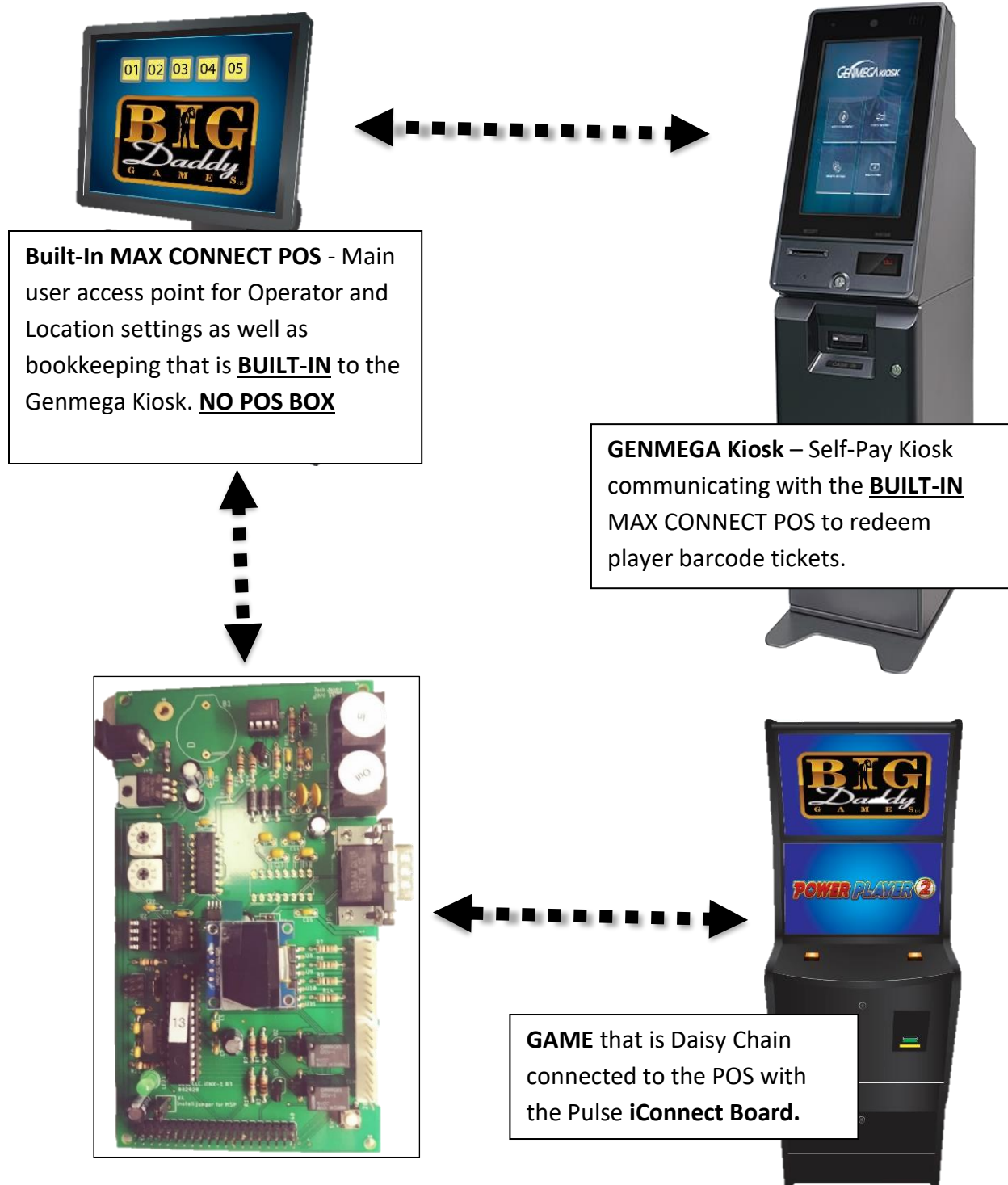

MAX CONNECT ADVANCE System Setup Overview



**MAX CONNECT is able to Daisy Chain connect up to 99 EGMS with the iConnect board.*

GENMEGA ATM Installation

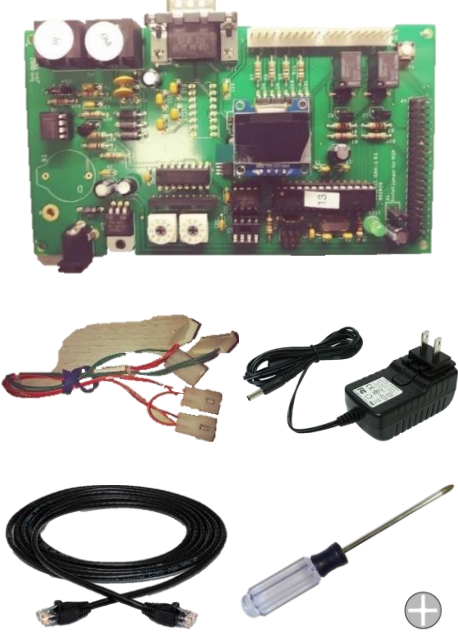
Items Required for MAX CONNECT Built-In and GENMEGA Kiosk Setup

<p>STEP 1 & STEP 2</p> <p>iConnect Board(s)</p> <p>iConnect TPI Harness(s)</p> <p>iConnect Power Supply(s)</p> <p>CAT-5 Ethernet Cable(s)</p> <p>Phillips Screwdriver</p>	
<p>STEP 3</p> <p>DTECH RS-232 to RS-485/RS-422 Converter</p> <ul style="list-style-type: none">• (1) Model DT-9017• (1) 9-pin RS232 male to female cable• (1) Power Adapter	

STEP 3 Connecting the DTECH DT-9017 Convert to the Kiosk should already be completed by BDG production.

Operators should only be required to follow STEP 1 Setting up the MAX CONNECT GAME System and STEP 2 Daisy-Chaining MAX CONNECT iConnect Boards.

GENMEGA ATM Installation

STEP 1 Setting up the MAX CONNECT GAME System

1. Connect the iConnect Wire Harness Power Supply (Green & Orange) to the GAME iConnect Board Pins

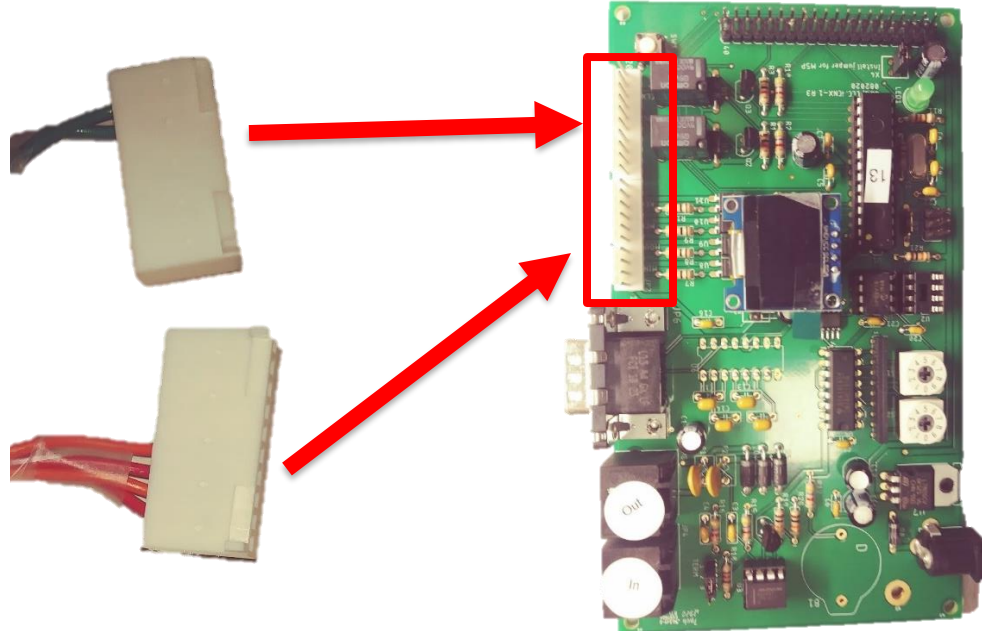

2. Connect iConnect Meter In (Red/Black) to GAME's Meter In Molex Connector.
3. Connect iConnect Meter Out (Red/White) to GAME's Meter Out Molex Connector.
4. Connect iConnect Ticket Out Button (Green) to GAME's Ticket Out Switch Connection.

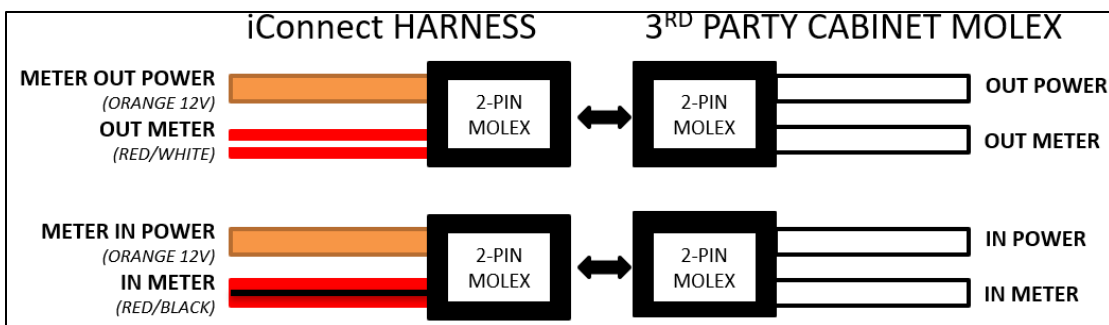
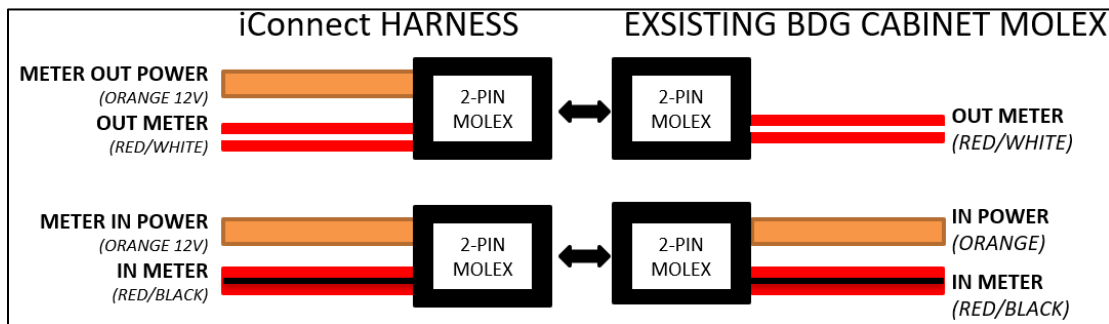

GENMEGA ATM Installation

5. Install the GAME iConnect Power Supply

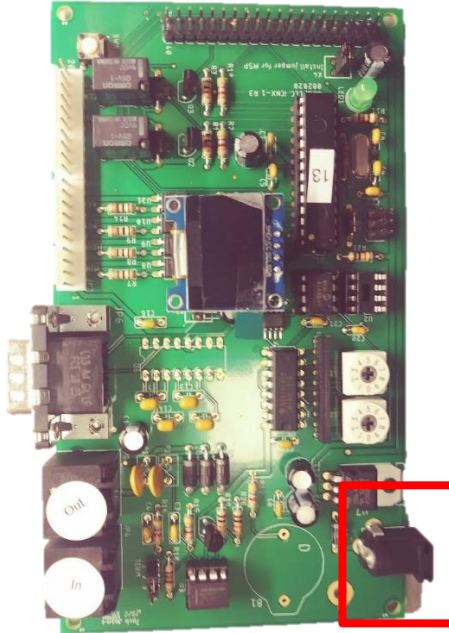

6. With the small Phillips screwdriver, set the Game Dials on the GAME iConnect Board to the corresponding GAME #.

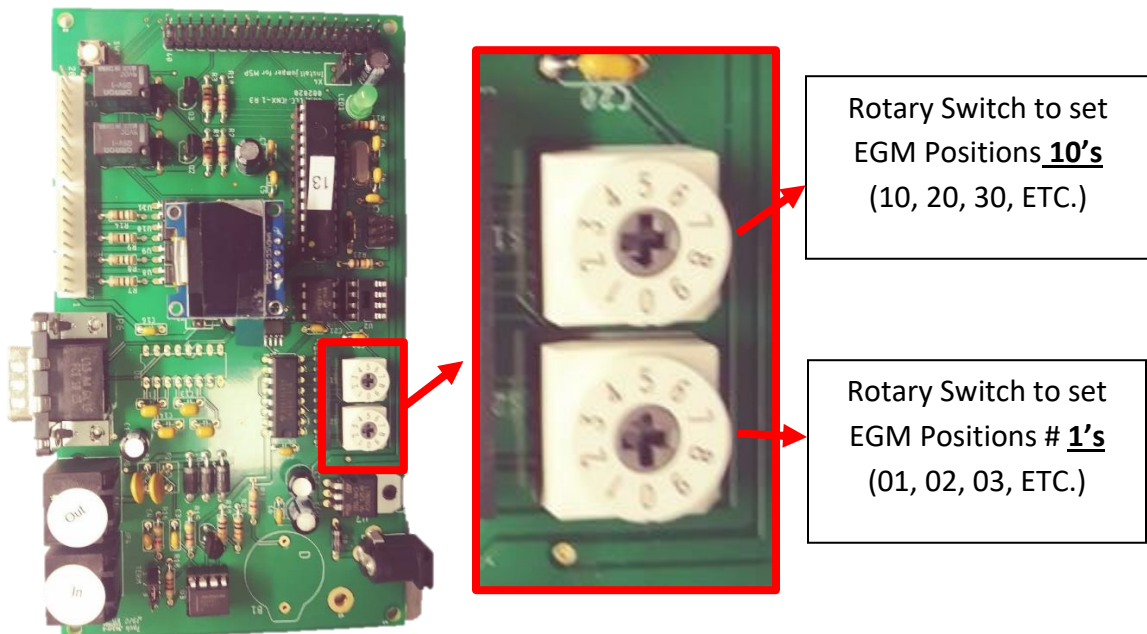

As you turn the Phillips screwdriver on the rotary dial, the GAME # on the iConnect Display will change numbers.

GENMEGA ATM Installation

7. Install the CAT5 Cable to the GAME iConnect Board's IN and OUT ports.

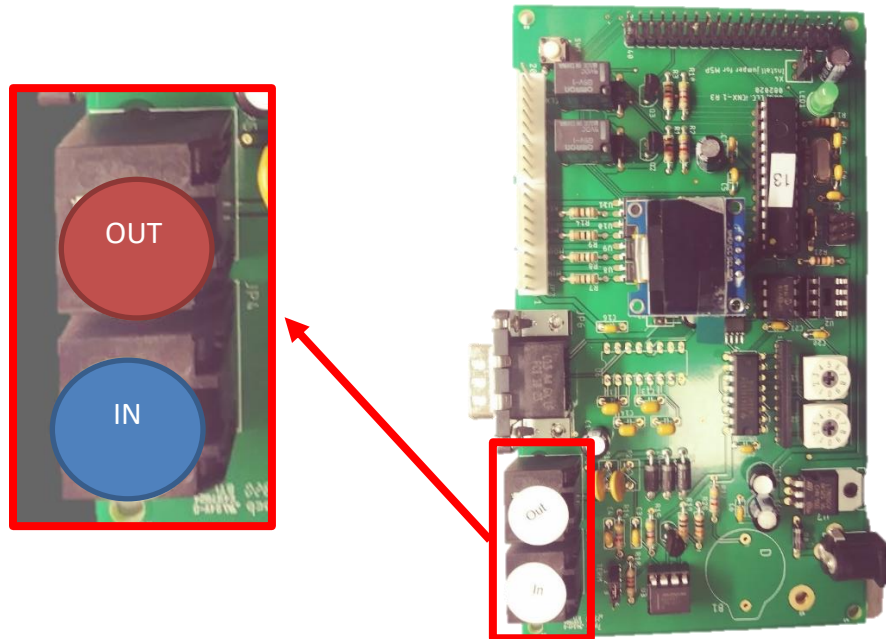

8. MAX CONNECT Single GAME setup is **PARTIALLY COMPLETED**. Follow the same steps as needed for additional GAMES.
9. In the **LAST GAME iConnect Board**, the Terminal Pin 1 and 2 **MUST BE CAPPED ON**.

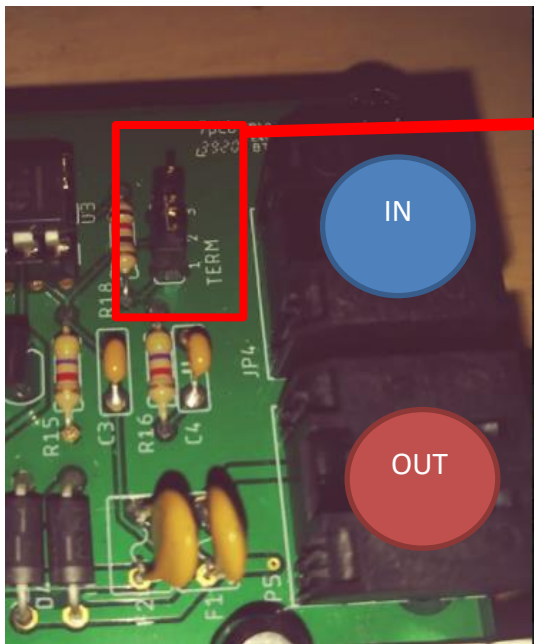

LAST iCONNECT BOARD TERMINAL PIN 1 & 2 CAPPED AND PIN 3 EXPOSED.

10. MAX CONNECT GAME SETUP COMPLETED.

GENMEGA ATM Installation

STEP 2 Daisy-Chaining MAX CONNECT iConnect Boards

1. From the **Kiosk's DTECH DT-9017 Ethernet Port**, connect the CAT5 to the **FIRST Game's iConnect OUT Port**.

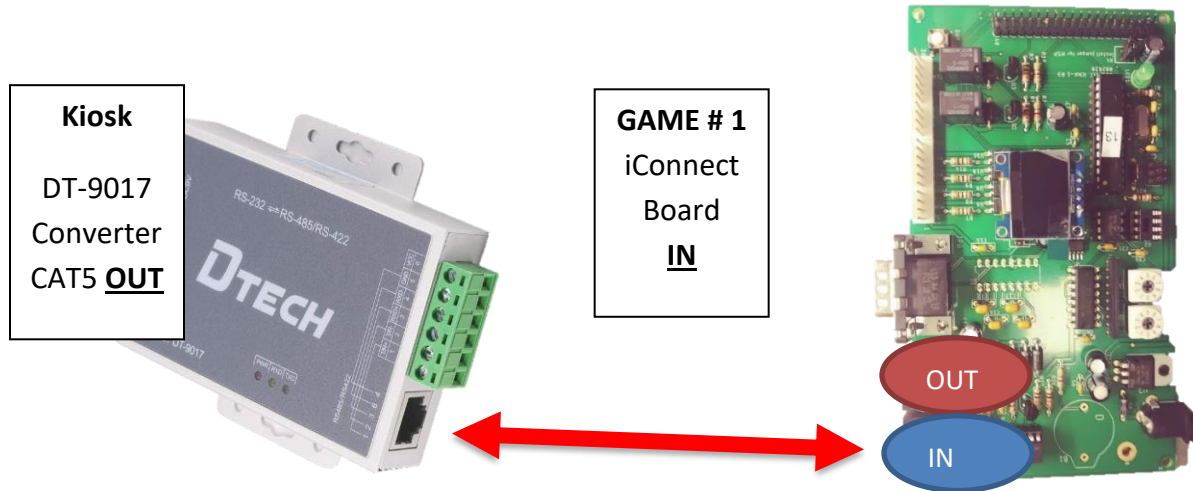

2. From the **FIRST GAME's IN Port**, connect the CAT5 to the **SECOND GAME's OUT Port**.

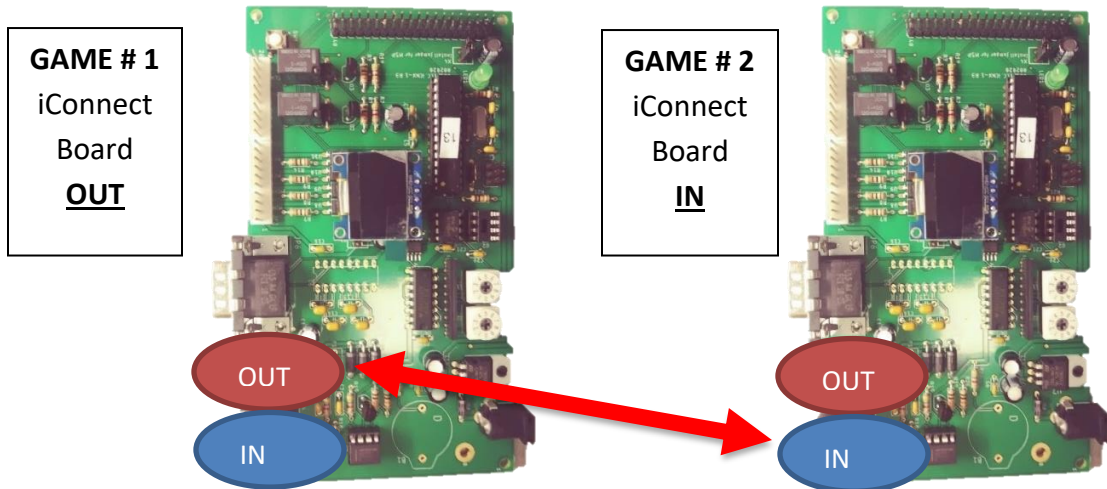

3. Continue as needed for additional GAME installation.
4. In the **LAST GAME's iConnect Board**, only the **IN Ethernet Port** is connected with the OUT Ethernet Port **UNUSED**. Reminder to ensure that the **TERMINAL PIN 1 and 2 are CAPPED** with **TERMINAL PIN 3 EXPOSED** in the **LAST GAME iConnect Board**.
5. On the Kiosk built-in Max Connect POS in ADMIN PAGE 1, set the Game Count for the # of iConnect Boards connected and REBOOT.

GENMEGA ATM Installation

6. On the Kiosk built-in Max Connect POS display, All of the GAME boxes should light up.



"OFFLINE"



"ONLINE"

7. If the GAME boxes are grayed out "OFFLINE" on the POS. Review Troubleshooting **Error!**
Reference source not found.
8. Insert credits to each GAME and ensure that the POS is recording Money In and Money Out.

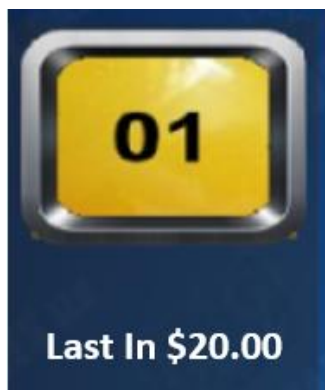

"CASH IN"

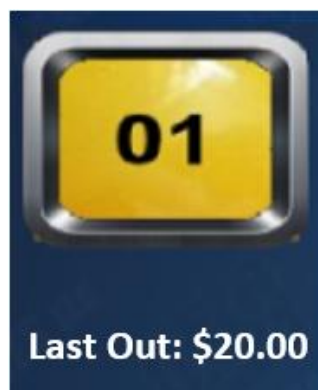

"CASH OUT"

9. Daisy-Chaining MAX CONNECT GAMES **COMPLETED.**

GENMEGA ATM Installation

STEP 3 Connecting the DTECH DT-9017 Convert to the Kiosk

This should already be completed by BDG Production.

1. Connect the RS232 male-end cable to the DB9 port converter.
2. Connect the RS232 female-end cable to the Kiosk's com port.
 - a. **COM 8** if **UK 2** or **UK 1**
 - b. **COM 2** if **GEMINI-D**
3. Connect the power supply to the DT-9017 Converter.
4. From the Kiosk built-in Max Connect POS in ADMIN PAGE 1, Change the FORMAT to BARCODE and enable the ATM to be ON.

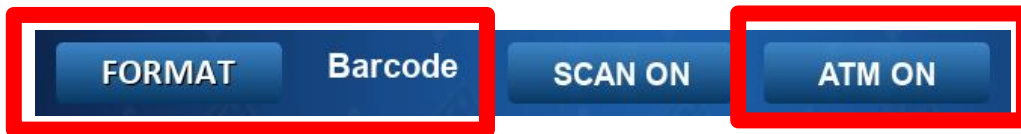

1. The ATM Kiosk status in the top-left corner will go from OFFLINE to ONLINE.
 - a. If ATM status does not update to ONLINE, reboot both the Kiosk.

DTECH DT-9017 Diagram

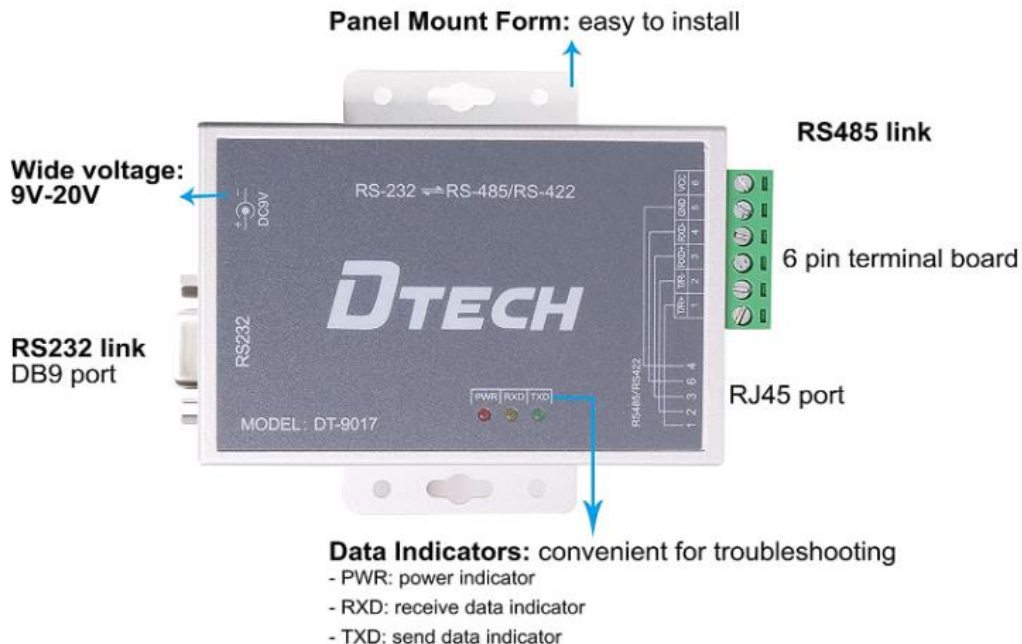

GENMEGA ATM Installation

GENMEGA UK 2 (UNIVERSAL KIOSK) SPECIFICATIONS

Main PC Platform

- Intel i5-7500 Processor
- Windows 10 IoT Enterprise
- 250GB SSD
- TCP/IP Ethernet

Touch-Screen LCD Display

- High-Res 21.5" touch screen LCD Panel
- 1920 x 1080 full-HD resolution

Receipt Printer

- 80mm Thermal Receipt Printer
- Automatic Paper Loading and Cutting
- 40 Characters per line
- 200 DPI mono-graphic printing

Magnetic Card Reader

- DIP Type EMV card reader
- Dual side card scan (image size: 1024 x 600 (color/gray))
- Feed Speed: 450mm/sec 10%

PIN Entry Device

- 16-key Alphanumeric keypad
- PCI 3.0 certified EPP (Encrypting Pin Pad)
- Triple-DES(TDES) compliant EPP

Barcode Scanner

- 2D/1D Image Scan Module High Visibility LED Aimer

Security

- Lockable safe vault available
- Electronic Lock

Topper

- High Visibility LED Sign (15.3" x4.1")

Cash Dispenser

- Up to 4 x 2,000 Note Removable Cassette

Bill Acceptor

- \$1, \$5, \$10, \$20, \$50, \$100 denomination bill acceptor(s)

Camera

- Full HD Camera

UPS

- APC350, Input 120v 50-60Hz, 210W/350VA

Dimensions

- 72.5" x 19.3" x 26"
- 330 lbs



GENMEGA ATM Installation

Genmega UK 2 Devices COM Port Assignment

PORT	DEVICE
COM1	MCR, EMV
COM2	EPP (PCI V3.X)
COM3	Bill Acceptor SCNXL66/83
COM4	2High HCDU
COM5	Receipt Printer
COM6	Flicker Lights #1 Receipt Printer #2 MCR #3 Cash Dispenser #4 EPP #6 Cash Light #8 Bill Acceptor Switch #1 CDU Safe #2 Top
COM7	Barcode Scanner
COM8	DTECH DT-9017 Daisy-Chain Connection
USB1	HD Camera
USB2	UPS
USB3	Fingerprint Reader
USB4	Not in use (Keyboard or Mouse)
USB5	Touchscreen
USB6	Not in use (Keyboard or Mouse)

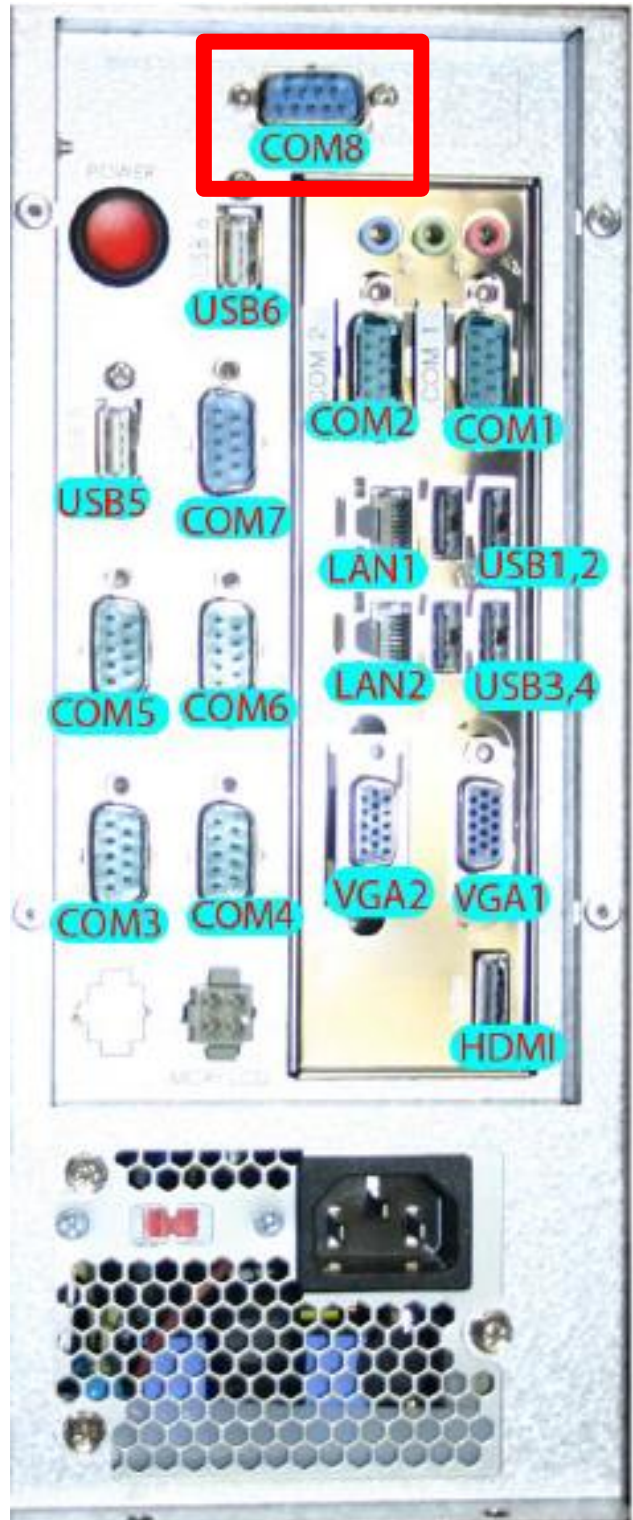

GENMEGA ATM Installation

Genmega GEMINI-D Specifications

Main PC Platform

- Intel Pentium
- Windows 10 IoT Value
- 250GB SSD
- TCP/IP Ethernet

Touch-Screen LCD Display

- High-Res 21.5" touch screen LCD Panel
- 1920 x 1080 full-HD resolution

Receipt Printer

- 80mm Thermal Receipt Printer
- Automatic Paper Loading and Cutting
- 40 Characters per line
- 200 DPI mono-graphic printing

Barcode Scanner

- 2D/1D Image Scan Module High Visibility LED Aimer

ADA

- Voice Guidance
- Lighted Transaction Guidance
- Accessible Keypad Layout

UPS (Optional)

- APC600

Camera (Optional)

- Full HD Camera

Bill Acceptor

- \$1, \$5, \$10, \$20, \$50, \$100 denomination bill acceptor(s)
- SCN serials (SCNL: 1,200 notes, SCNXL: 2,200 notes)

Security

- UL-291 certificated
- Lockable safe vault available
- Electronic Lock (option. A-series / Cencon)



GENMEGA ATM Installation

Genmega GEMINI-D Devices COM Port Assignment

PORT	DEVICE
COM1	Barcode Scanner
COM2	DTECH DT-9017 Daisy-Chain Connection
COM3	Not in Use
COM4	Cash Dispensing Unit (CDU)
COM5	Receipt Printer
COM6	Flicker Lights #1 Receipt Printer #2 Barcode #3 Bill Acceptor Switch #1 Bill Safe
USB1	Camera
USB2	UPS
USB3	Barcode Scanner
USB4	Touchscreen
USB5	Not in Use
USB6	Not in Use
USB7	Not in Use

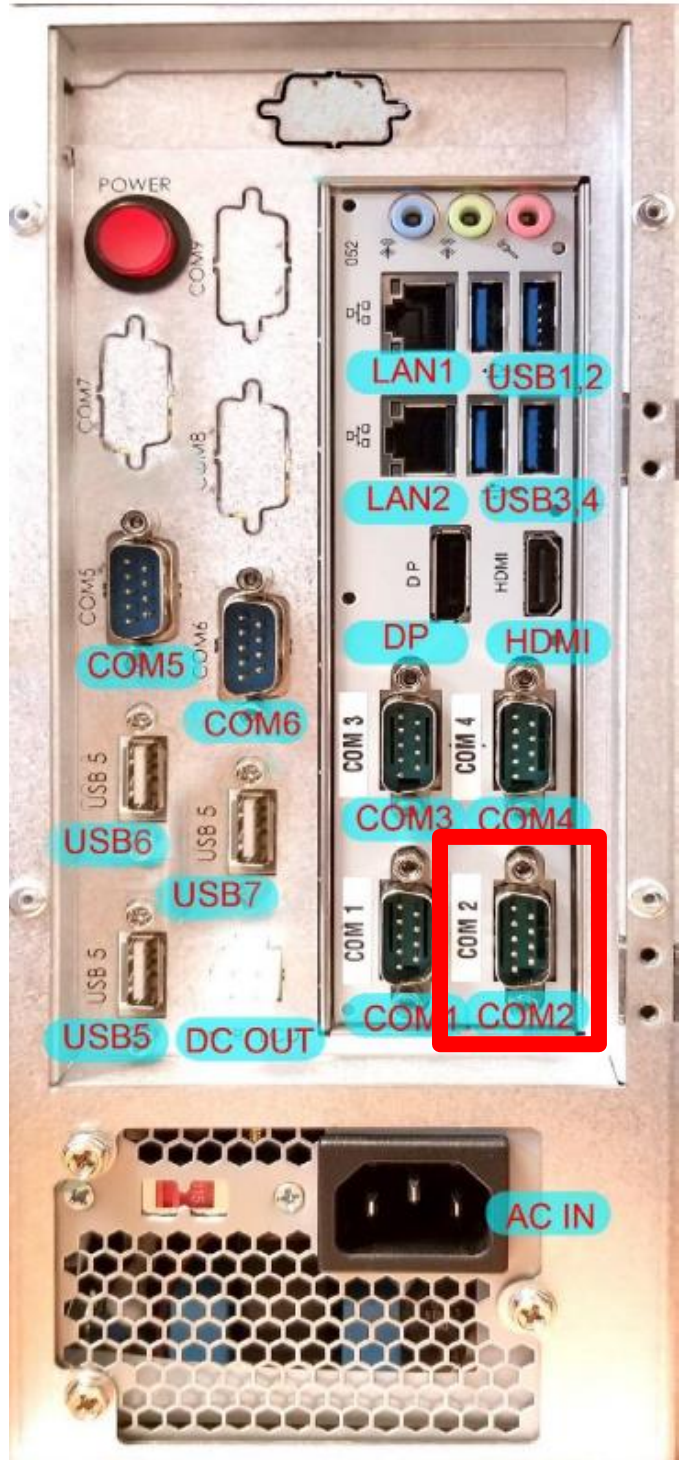

Visit us at www.bigdaddygames.net for the latest and newest GAMES available for your Market!

OPERATORS LOG-IN TODAY for the latest Service Bulletin News and Software Updates!



TECH - DIRECT

920.850.7409

After Hours of Support Service Calls:

MONDAY - THURSDAY Close of business **4:15PM - 8PM**
FRIDAY Close of business **3PM - 8PM**
SATURDAY **10AM - 6PM**
SUNDAY **Noon - 4PM**
Except Holidays

Service Support during business hours
(920) 727-5508 ext. 176 OR (920) 850-7409

733 Midway Rd. Menasha, WI 54952
bigdaddygames.net

Big Daddy Games LLC



Big Daddy Games LLC
733 Midway Road
Menasha, WI 54952

TEL: (920) 727-5508

www.bigdaddygames.net
sales@bigdaddygames.net

TECH-DIRECT
(920) 850-7409